

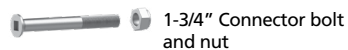

## Tools and Materials Needed

- Mitre saw (recommended) or hacksaw with non-ferrous metal cutting blade
- Level
- Measuring tape
- Drill
- Drill bits for wood: 5/32", 1/4", 3/8"
- Drill bits for metal: 1/8", 7/32"
- Square #1, #2, #3 driver bits
- T40 star driver bit
- Socket or hex driver: 3/8"
- Sockets: 1/2", 9/16"
- Wrenches: 1/2", 9/16"
- Clamps
- Painters tape
- Dish soap (for 18" - 66" glass panels)
- Concrete anchoring fasteners (for concrete applications only, see page 3 for details)
- Non-corrosive exterior silicone caulking

## Fasteners Supplied

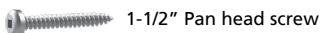
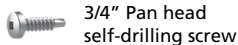
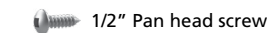

Dear Customer,

We'd like to take a moment to say "thank you and congratulations" for choosing our products. At Peak® your satisfaction is very important to us. That is why we work very hard to provide you with products of exceptional quality, value, and beauty. And that is also why we want to hear from you.

Please contact us with your comments or suggestions at: [cservice@peakproducts.com](mailto:cservice@peakproducts.com)

Finally, we'd like to remind you to always work safely. Then, take pride, relax with your family and experience years of enjoyment with Peak® products.

The Peak Group of Companies

---

## IMPORTANT INFORMATION

- Before beginning work, read this installation guide in its entirety including all warnings and important information.
- This installation guide is updated occasionally. Please refer to the latest version at [railblazers.ca/installation-guide/](http://railblazers.ca/installation-guide/)
- Maximum post spacing for Residential\* use:  
decks: 6' 0"    stairs: 5' 10"  
\*Guards within dwelling units and exterior guards serving not more than two dwelling units.
- For commercial use including multi-residential housing, please call Peak Customer Service at 1-877-883-PEAK (7325) or email: [cservice@peakproducts.com](mailto:cservice@peakproducts.com)
- Stair Railing Kits are designed for use on common stairs with an angle of 32° - 38°.
- Always understand and comply with your local building codes.+  
+Conditions apply. For details visit: [railblazers.ca/compliance/](http://railblazers.ca/compliance/)
- To prevent wood splitting and rot, drill pilot holes and coat fastener screw threads with non-corrosive exterior silicone caulking.
- For standard Picket railing sections, ensure that the opening between each of the following is less than 81.5 mm (3-3/16"):
  - adjacent pickets, pickets and posts, pickets and walls, pickets and glass panels, base rail and deck surface.
- For Wide Picket railing sections, ensure that the opening between each of the following is less than 96 mm (3-3/4"):
  - adjacent wide pickets, wide pickets and posts, wide pickets and walls, wide pickets and glass panels, base rail and deck surface.
- For large Glass Panel and 6" Glass Panel railing sections, ensure that the opening between each of the following is less than 100 mm (3-15/16"):
  - glass panels, glass panels and posts, glass panels and walls, base rail and deck surface.

---

**⚠WARNING** No representation or warranty is given that your particular application of these products complies with relevant building codes or that the fasteners provided or used are appropriate for your application. Consult with professionals and local building officials before beginning work: (i) to ensure compliance with relevant building codes for your application and for your proposed use of fasteners; (ii) to ensure the integrity of the structural components in connection with which these products are to be used; (iii) to identify appropriate safety gear that is to be used during installation such as a safety harness when working above ground; (iv) to ensure that the work area is free from utilities, services and hazards; and (v) to clarify any instructions or warnings that may not be clear. Work in a safe manner wearing protective gear such as gloves, eyewear, headwear, footwear and clothing. When using tools comply with operation manuals and instructions. Metal and glass may have sharp edges and could fragment or splinter during or as a result of handling or cutting. Do not use these products in connection with any substance that is or may be harmful or corrosive to the products. Inspect and maintain these products and the structural components that they are used in connection with on a regular basis, using professionals when appropriate. Obtain professional advice for any non-standard or non-residential application. No member of The Peak Group of Companies (as defined at [www.peakproducts.com](http://www.peakproducts.com)) shall be liable for any loss or damage resulting from the improper installation or use of this product. In the unlikely event that any member of The Peak Group of Companies becomes liable for any loss or damage, the aggregate liability shall be limited to the retail purchase price of the product.

Peak products and associated materials are protected by patents, designs, copyrights and/or trademarks used under license from Peak Innovations Inc.

# ANCHORING FASTENERS

For typical single-family detached houses, engineering design and testing has determined appropriate fasteners for the attachment of the post base, wall bracket, and fascia bracket to certain wood or concrete structures. Building codes may vary. Always understand and comply with your local building codes. For further information visit: [railblazers.ca/compliance/](http://railblazers.ca/compliance/)

For commercial use including multi-residential housing, please call Peak Customer Service at 1-877-883-PEAK (7325) or email: [cservice@peakproducts.com](mailto:cservice@peakproducts.com)

POST BASE typical anchoring fasteners				
Deck Structure	Fasteners Required	Minimum Embedment <sup>1</sup>	Minimum Edge Distance	Pilot Hole
New SPF Lumber	4 x 3/8" x 6" Self-drilling wood screw (provided with product)	3-1/2"	3/4"	not required
Concrete 20 MPa (3000 psi) minimum strength	4 x 3/8" x 3" Buildex Tapcon + (not provided)	2-1/2"	1-3/8"	3/8"

WALL BRACKET typical anchoring fasteners				
Deck Structure	Fasteners Required	Minimum Embedment <sup>1</sup>	Minimum Edge Distance	Pilot Hole
New SPF Lumber	4 x 1/4" x 2" Lag Bolt (provided with product)	1"	3/8"	5/32"
Concrete 20 MPa (3000 psi) minimum strength	4 x 1/4" x 2-1/4" Buildex Tapcon (not provided)	2"	1-3/8"	3/16"

FASCIA BRACKET typical anchoring fasteners				
Deck Structure	Fasteners Required	Minimum Embedment <sup>1</sup>	Minimum End Distance	Pilot Hole
New SPF Lumber	Mid/End/Stair Bracket: 6 x 3/8" x 4" Lag bolt (provided with product)	3"	1"	1/4"
	Corner Bracket: 4 x 3/8" x 4" Lag bolt (provided with product)	3"	1"	1/4"

<sup>1</sup> Depth of the threaded portion of the screw into the supporting structure.

# PICKET INSTALLATION

 This symbol indicates important information.

 Pickets & Spacers are designed for Residential<sup>1</sup> use only. Wide Pickets & Spacers are designed for Residential<sup>1</sup> or Commercial<sup>2</sup> use.

<sup>1</sup> Guards within dwelling units and exterior guards serving not more than two dwelling units.

<sup>2</sup> For more information, please call Peak Customer Service at 1-877-883-PEAK (7325) or email: [cservice@peakproducts.com](mailto:cservice@peakproducts.com)

 For wall bracket, horizontal angle bracket or fascia bracket installation, please see pages 13-15.

**1** Measure and mark the position of all posts and space equally.

 Maximum post spacing of 6' for Residential\* use. For commercial use, please call Peak Customer Service at 1-877-883-PEAK (7325) or email: [cservice@peakproducts.com](mailto:cservice@peakproducts.com)

\*Guards within dwelling units and exterior guards serving not more than two dwelling units.

Put the first post in position. For wood attachment, install four 6" self-drilling lag screws with washers through each corner of the post base. Ensure that the post is plumb.

 To prevent splitting of deck boards, drill four 1/4" pilot holes through deck boards (but not into deck structure).

 To prevent wood rot, coat fastener screw threads with non-corrosive exterior silicon caulking.

 For concrete attachment, refer to page 3 for anchoring fastener recommendations.

**2** Temporarily position the second post but do NOT secure it yet. Cut the hand and base rails and plastic picket gaskets to fit between the posts.

**3** **A:** Install the base rail support into the bottom channel of the base rail.

 To ensure that the pickets remain engaged in the rails, you must install one base rail support for each railing section.

**B:** Install all but the last four spacers into each rail.

**4** Insert the rails (fitted with plastic picket gaskets) into the first post. Then insert the rails into the second post as a temporary support but do not secure it yet.

**A:** Secure the handrail to the first post with 3/4" pan head self-drilling screws.

**B:** Secure the base rail to the first post with 3/4" pan head self-drilling screws.

**C:** Slide the first spacer in each rail against the first post.

**D:** Insert a picket into the base rail and swing the top of the picket into the handrail. Repeat until you can no longer swing pickets into position.

 For standard Picket railing sections, ensure that the opening between pickets, and a picket and a post does not exceed 81.5 mm (3-3/16").

 For Wide Picket railing sections, ensure that the opening between wide pickets, and a wide picket and a post does not exceed 96 mm (3-3/4").

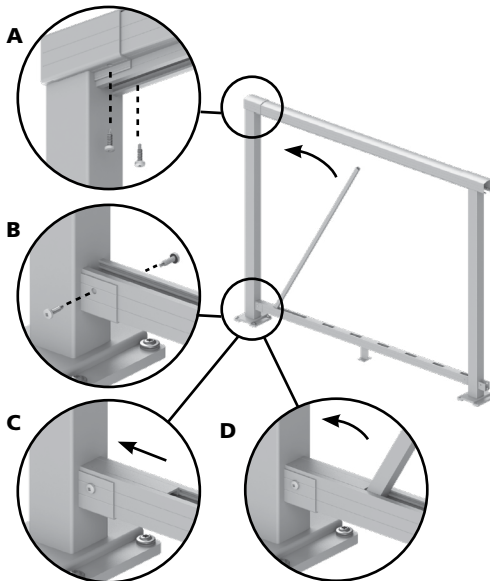
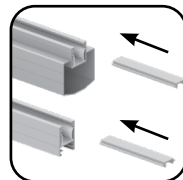
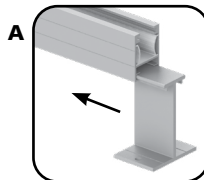
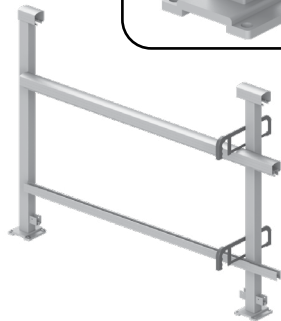

5

- A:** Remove the second post to install the last few pickets and spacers.
- B:** Cut the last spacers flush with the ends of the rails.

**!** To ensure equal picket spacing at each post, cut the first and the last spacers in the hand and base rails to equal lengths.

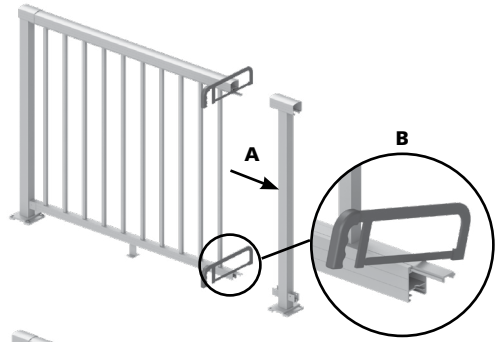

6

- A:** Insert the rails into the second post.
- B:** Position and fasten the second post in place, ensuring that the post is plumb (see step 1 for full details).

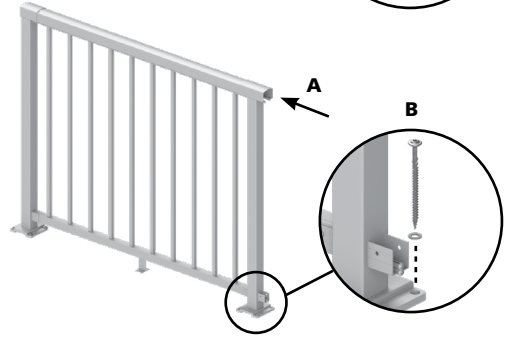

7

- A:** Secure the handrail to the second post with 3/4" pan head self-drilling screws.
- B:** Secure the base rail to the second post with 3/4" pan head self-drilling screws.
- C:** Slide the base rail support to the centre position.
- D:** Fasten the base rail support to the deck using two 1-1/2" pan head screws.

**!** To ensure that the pickets remain engaged in the rails, you must install one base rail support for each railing section.

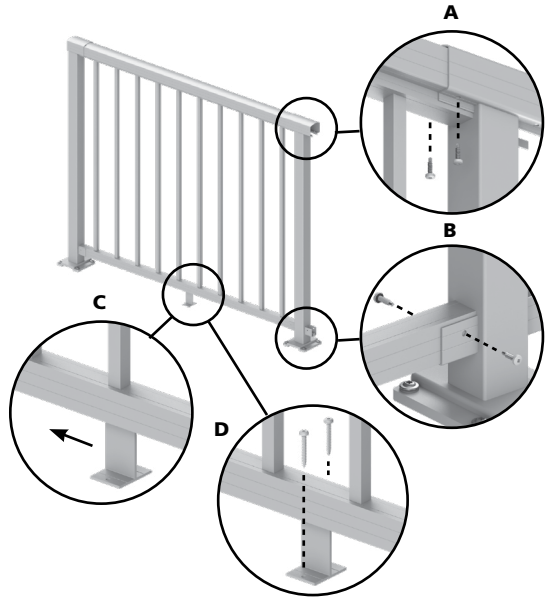

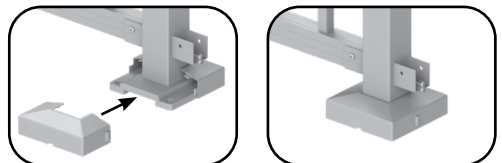

8

- Install the post base covers.
- Repeat all steps for remaining sections.



# 18" - 66" GLASS PANEL INSTALLATION

 This symbol indicates important information.

 Always use two people to handle glass panels. Always lift a glass panel by its sides. Tempered glass is extremely fragile – do not bump the edges. Always use protective gear including eyewear and gloves when handling glass panels.

 For wall bracket, horizontal angle bracket or fascia bracket installation, please see pages 13-15.

**1** Measure and mark the position of all posts and space equally.

 Maximum post spacing of 6' for Residential\* use. For commercial use, please call Peak Customer Service at 1-877-883-PEAK (7325) or email: [cservice@peakproducts.com](mailto:cservice@peakproducts.com)

\*Guards within dwelling units and exterior guards serving not more than two dwelling units.

Put the first post in position. For wood attachment, install four 6" self-drilling lag screws with washers through each corner of the post base. Ensure that the post is plumb.

 To prevent splitting of deck boards, drill four 1/4" pilot holes through deck boards (but not into deck structure).

 To prevent wood rot, coat fastener screw threads with non-corrosive exterior silicon caulking.

 For concrete attachment, refer to page 3 for anchoring fastener recommendations.



**2** **A:** Remove the plastic picket gaskets from both rails.

**B:** Temporarily position the second post but do NOT secure it yet. Cut the hand and base rails to fit between the posts.

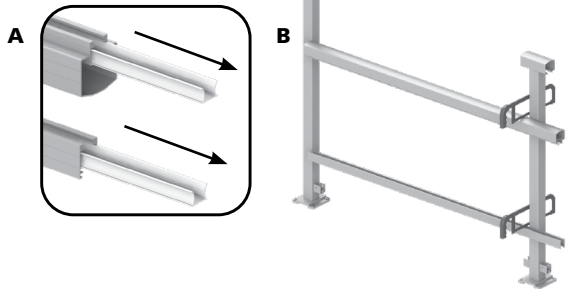

**3** **A:** Cut the glass gaskets the same length as the rails.

**B:** Drill 1/8" holes into the base rail glass gasket (the smaller gasket) every 12" for water drainage.

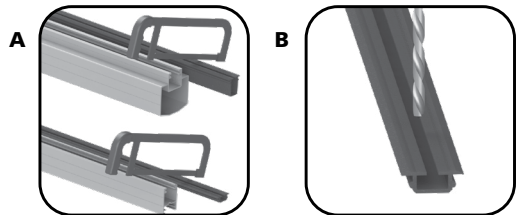

**4** **A:** Press the glass gaskets into the rails.

 The smaller of the two glass gaskets goes into the base rail.

**B:** Install the base rail support into the bottom channel of the base rail.

 To ensure that the glass panel remains engaged in the rails, you must install one base rail support for each railing section.

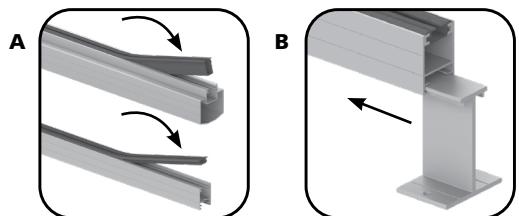

- 5** **A:** Insert the rails into the posts.  
**B:** Position and fasten the second post in place, ensuring that the post is plumb (see step 1 for full details).  
**C:** Slide the base rail support to the centre position.  
**D:** Fasten the base rail support to the deck using two 1-1/2" pan head screws.

**!** To ensure the glass panel remains engaged in the rails, you must install one base rail support for each railing section.

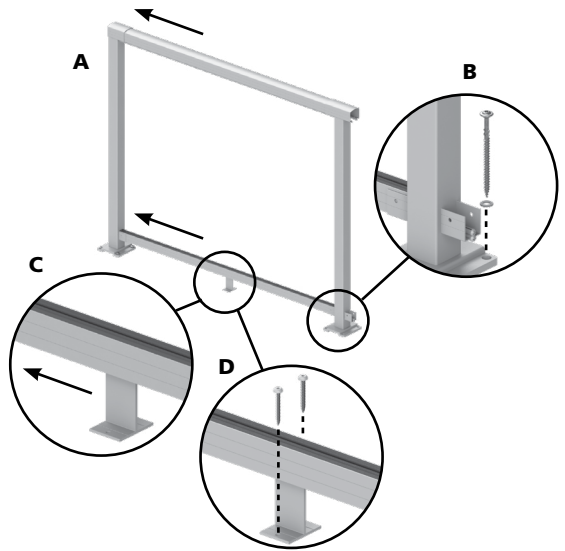

- 6** Secure the rails to both posts with 3/4" pan head self-drilling screws.

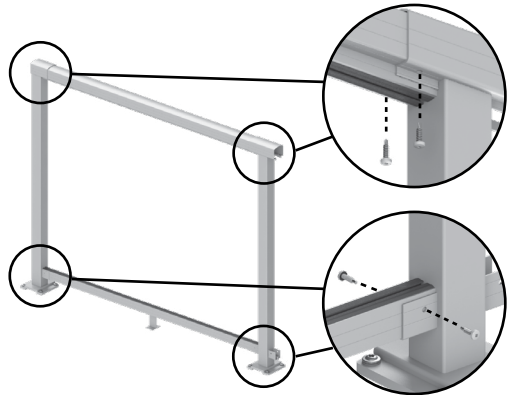

- 7** Install the glass panel by inserting it into the handrail gasket then lowering it into the base rail gasket.

- !** Ensure that the glass gaskets and the top and bottom edges of the glass panel are well lubricated with liquid soap before installing the glass panel.  
**!** Ensure that the glass is fully seated in the gaskets. Wash away excess soap with clean water.  
**!** The opening between a glass panel and a post must not exceed 3-15/16".

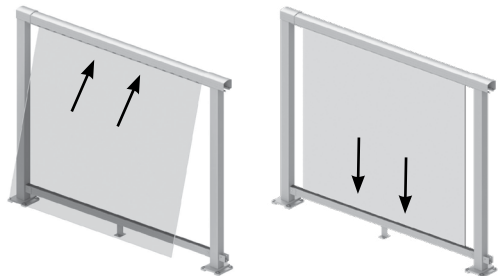

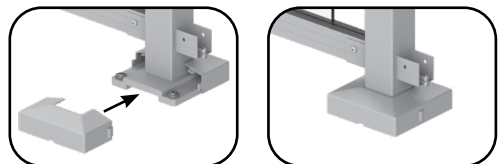

- 8** Install the post base covers. Repeat all steps for remaining sections.



# 6" GLASS PANEL KIT INSTALLATION



 This symbol indicates important information.

-  Always lift a glass panel by its sides. Tempered glass is extremely fragile – do not bump the edges. Always use protective gear including eyewear and gloves when handling glass panels.
-  For wall bracket, horizontal angle bracket or fascia bracket installation, please see pages 13-15.

**1** Measure and mark the position of all posts and space equally.

-  Maximum post spacing of 6' for Residential\* use. For commercial use, please call Peak Customer Service at 1-877-883-PEAK (7325) or email: [cservice@peakproducts.com](mailto:cservice@peakproducts.com)
- \*Guards within dwelling units and exterior guards serving not more than two dwelling units.

Put the first post in position. For wood attachment, install four 6" self-drilling lag screws with washers through each corner of the post base. Ensure that the post is plumb.

-  To prevent splitting of deck boards, drill four 1/4" pilot holes through deck boards (but not into deck structure).
-  To prevent wood rot, coat fastener screw threads with non-corrosive exterior silicon caulking.
-  For concrete attachment, refer to page 3 for anchoring fastener recommendations.

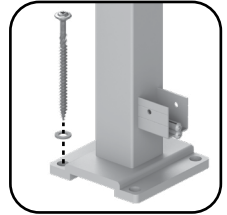

**2** **A:** Remove the plastic picket gaskets from both rails.  
**B:** Temporarily position the second post but do NOT secure it yet. Cut the hand and base rails to fit between the posts.

-  This kit was designed to fit into a 6' railing section. If your railing section is shorter than 6', you will need to cut the spacers or remove the glass panel(s) accordingly.

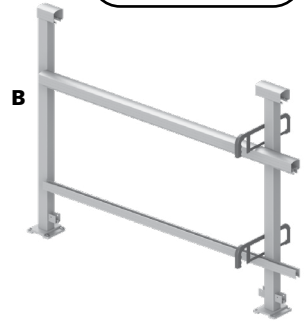
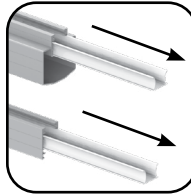

**3** **A:** Install the base rail support into the bottom channel of the base rail.

-  To ensure that the glass panels remain engaged in the rails, you must install one base rail support for each railing section.

**B:** Install the first pair of spacers in the hand and base rails.

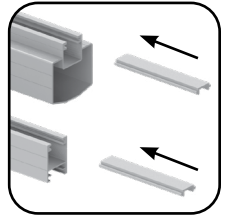
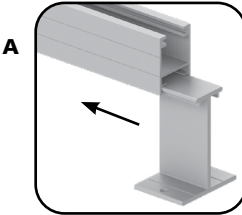

**4** Insert the rails into the first post. Then insert the rails into the second post as a temporary support but do not secure it yet.

- A:** Secure the handrail to the first post using 3/4" pan head self-drilling screws.
- B:** Secure the base rail to the first post with 3/4" pan head self-drilling screws.
- C:** Slide the first spacer in each rail against the first post.

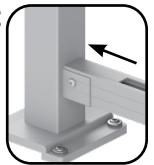
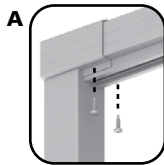

**5** Remove the second post.  
**A:** Attach the glass fittings to the top and bottom of each glass panel.

**B:** Slide a glass panel with fittings attached into the rails until touching the first pair of spacers. Then slide the second pair of spacers into the hand and base rails. Repeat to complete the section.

-  The opening between glass panels, and a glass panel and a post must not exceed 3-15/16".

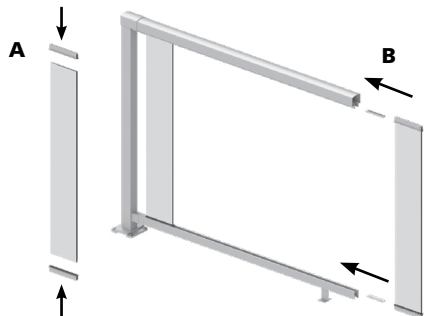

**6** Cut the last spacers flush with the ends of the rails.

**!** To ensure equal glass panel spacing at each post, cut the first and the last spacers in the hand and base rails to equal lengths.

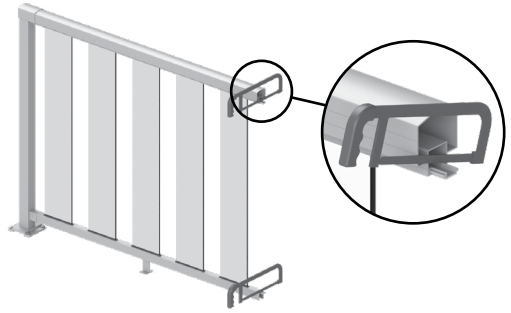

**7** **A:** Insert the rails into the second post.  
**B:** Position and fasten the second post in place, ensuring that the post is plumb (see step 1 for full details).

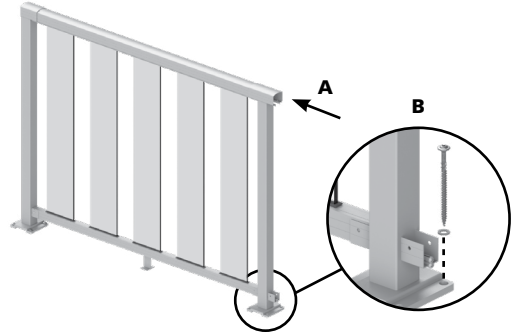

**8** **A:** Secure the handrail to the second post with 3/4" pan head self-drilling screws.  
**B:** Secure the base rail to the second post with 3/4" pan head self-drilling screws.  
**C:** Slide the base rail support to the centre position.  
**D:** Fasten the base rail support to the deck using two 1-1/2" pan head screws.

**!** To ensure that the glass panels remain engaged in the rails, you must install one base rail support for each railing section.

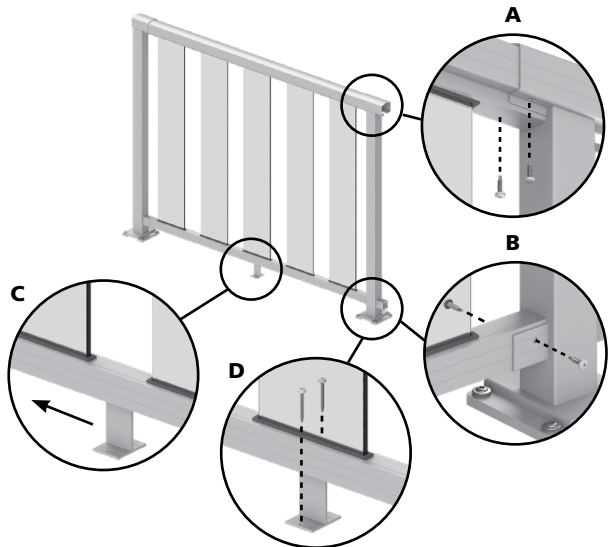

**9** Install the post base covers.  
Repeat all steps for remaining sections.

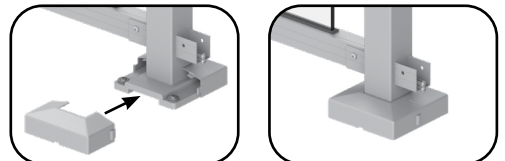

# STAIR PICKET INSTALLATION

**!** This symbol indicates important information.

**!** Stair Railing Kits are designed for use on common stairs with an angle of 32° - 38°.

**!** Stair Railing Kits with Standard Pickets are designed for Residential<sup>1</sup> use only.

Stair Railing Kits with Wide Pickets are designed for Residential<sup>1</sup> or Commercial<sup>2</sup> use.

<sup>1</sup> Guards within dwelling units and exterior guards serving not more than two dwelling units.

<sup>2</sup> For more information, please call Peak Customer Service at 1-877-883-PEAK (7325) or email: [cservice@peakproducts.com](mailto:cservice@peakproducts.com)

**1** Measure and mark the position of all posts and space equally.

**!** Maximum post spacing of 5' 10" for Residential\* use. For commercial use, please call Peak Customer Service at 1-877-883-PEAK (7325) or email: [cservice@peakproducts.com](mailto:cservice@peakproducts.com)

\*Guards within dwelling units and exterior guards serving not more than two dwelling units.

Put the top post in position. For wood attachment, install four 6" self-drilling lag screws with washers through each corner of the post base. Ensure that the post is plumb.

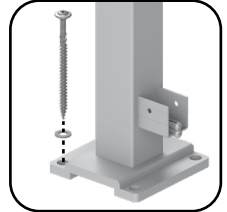

**!** To prevent splitting of deck boards, drill four 1/4" pilot holes through deck boards (but not into deck structure).

**!** To prevent wood rot, coat fastener screw threads with non-corrosive exterior silicon caulking.

**!** For concrete attachment, refer to page 3 for anchoring fastener recommendations.

**2** **A:** Remove the screw covers from the rails.

**B:** Insert a picket through the first and last square slots at each end of the base rail (ensure the screw holes in the rails and pickets are facing up). Align the screw hole in each picket with the screw hole in the base rail, then fasten each picket to the rail using 1/2" pan head screws.

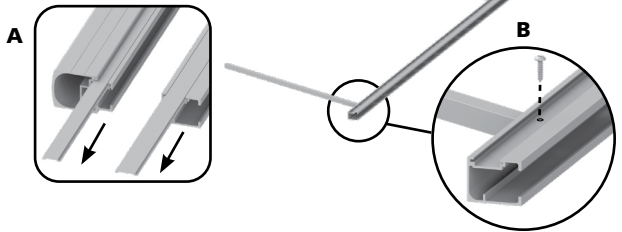

**3** Insert the pickets into each end of the handrail (ensure the screw holes in the rail are facing up). Align the screw hole in each picket with the screw hole in the handrail, then fasten each picket to the rail using 1/2" pan head screws.

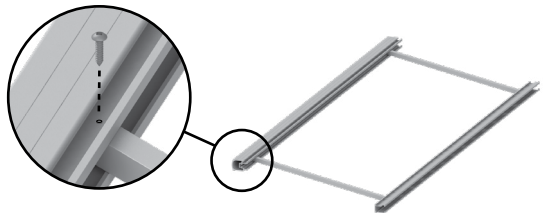

**4** **A:** Insert the next picket through the square slot in the base rail.

**B:** Insert picket into the handrail and align the screw holes with the screw holes in the rails. Fasten picket to the rails using 1/2" pan head screws. Repeat to complete the panel.

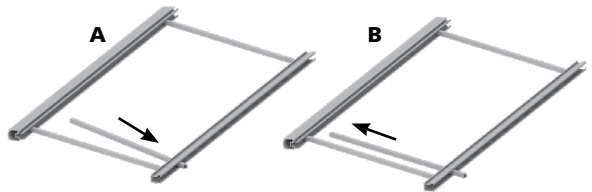

**5** **A:** Install the handrail screw cover.

**B:** Install the base rail screw cover.

**!** Secure the screw covers to the rails with painter's tape to prevent them from sliding during the remainder of the installation.

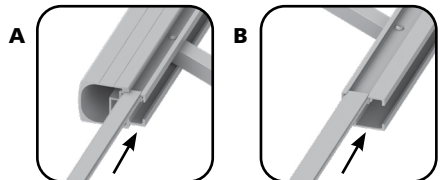

**6** ⚠️ Ensure the posts and railing panel are positioned so that the bottom of the base rail meets each post no more than 3-1/2" above the top of the post base.

⚠️ Always understand and comply with your local building codes for stair rail height and size of openings under the base rail.

⚠️ For standard Picket railing sections, ensure that the opening between each of the following is less than 81.5 mm (3-3/16"): adjacent pickets, pickets and posts.

⚠️ For Wide Picket railing sections, ensure that the opening between each of the following is less than 96 mm (3-3/4"): adjacent wide pickets, wide pickets and posts.

Put the railing panel and bottom post into position and clamp the posts and rails together but do not secure the bottom post yet. Ensure equal picket spacing at each post, and that the bottom post is plumb. To allow space for the brackets, mark a vertical line 3/8" away from each post and cut the rails along the marked line.

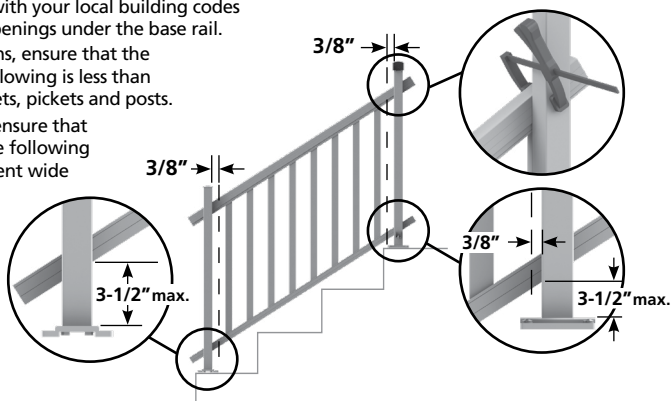

**7** **A:** Reposition the railing panel in between the posts at the required height above the noses of the treads. Place and mark positions of each base rail bracket. Then remove the panel in order to mark hole positions for each bracket on the posts.

**B:** Drill 7/32" pilot holes through the post at the marked positions.

**C:** Fasten the base rail brackets to the posts, using four 1" flat head screws.

**D:** Position and fasten the bottom post in place, ensuring that the post is plumb (see step 1 for full details).

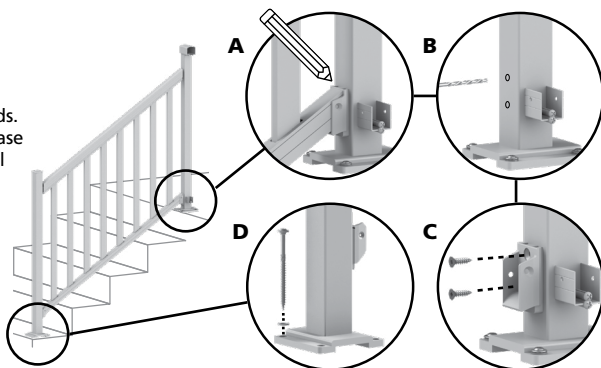

**8** **A:** Temporarily position the railing panel in the base rail brackets and mark the position of the bracket and hole positions of each handrail bracket on the posts.

**B:** Drill 7/32" pilot holes through the post at the marked positions.

**C:** Fasten the handrail brackets to the posts, using four 1" flat head screws.

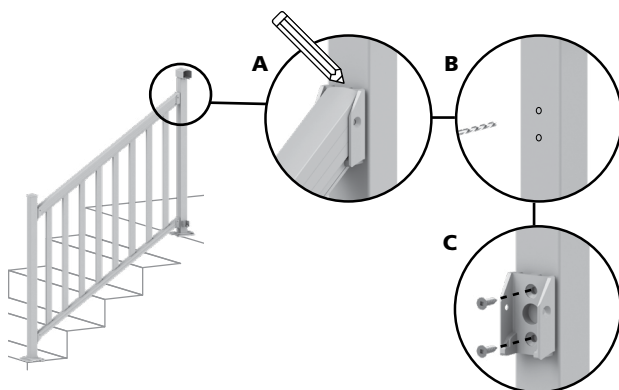

**9** **A:** Reposition the railing panel, then drill 1/8" pilot holes through the rails at the screw positions.

**B:** Attach the railing panel to the brackets and secure with 3/4" flat head screws.

**C:** Slide a screw cover over each bracket.

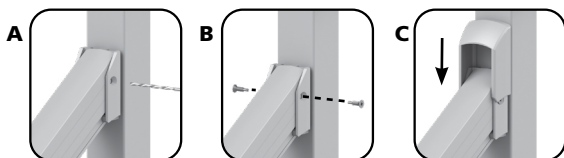

**10** Install the post base covers. Repeat all steps for remaining sections.

# GATE INSTALLATION

 This symbol indicates important information.

 Before beginning work, measure and ensure the Gate Opening (W) does not exceed 46". Then please carefully follow the steps below to ensure the gate is not cut too short for your project.

- 1**
- A:** Remove latch side of gate frame.
  - B:** With latch side of gate frame removed, cut top and bottom gate rails 7-1/2" shorter than gate opening W.

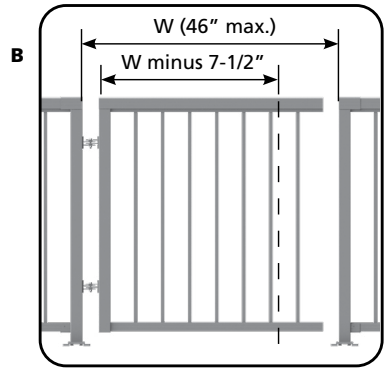
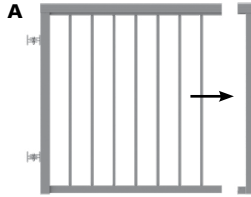

- 2**
- Attach the latch side of the gate frame using the 3/4" pan head self-drilling screws.

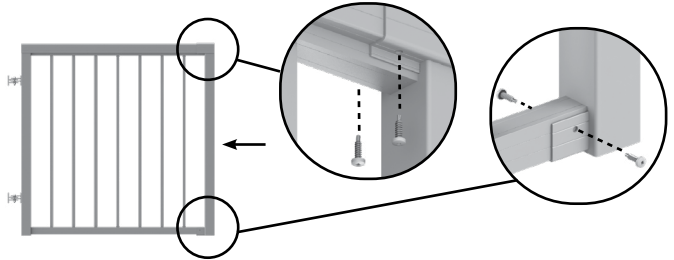

- 3**
- A:** Align the top of the gate with the top of the post and mark the hole positions for the hinges on the post.
  - B:** Drill 7/32" pilot holes at the marked positions.
  - C:** Install the top 2" lag bolt on each hinge.
  - D:** Install the bottom 2" lag bolt on each hinge by releasing the bolt and nut (do not completely disassemble hinge).

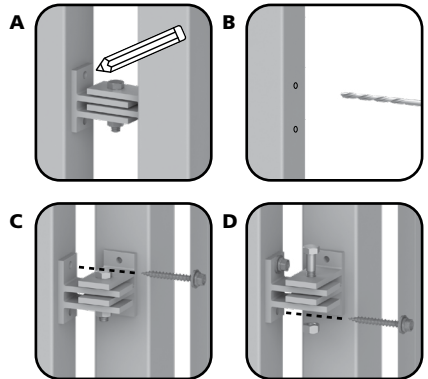

- 4**
- Use 3/4" pan head self drilling screws for these steps:
- A:** Secure the retainer to the gate at the marked position.
  - B:** Insert the latch through the retainer.
  - C:** Secure the latch to the gate at the marked position.
  - D:** Check and mark the position for the latch plate on the post. Secure the latch plate to the post.

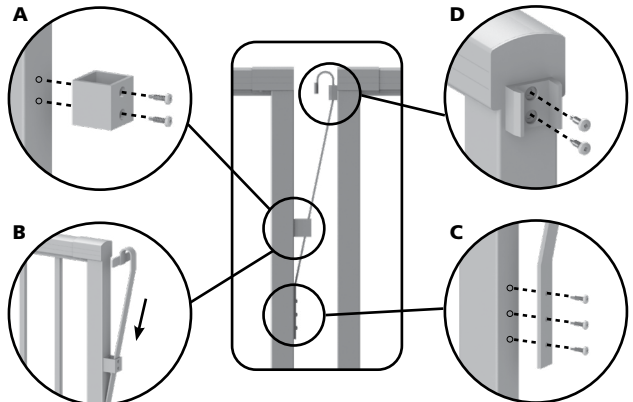

# WALL BRACKET INSTALLATION

 This symbol indicates important information.

**1** Measure and mark the position of all brackets on the wall.

 Maximum wall bracket spacing of 6' for Residential\* use. For commercial use, please call Peak Customer Service at 1-877-883-PEAK (7325) or email: [cservice@peakproducts.com](mailto:cservice@peakproducts.com)

\*Guards within dwelling units and exterior guards serving not more than two dwelling units.

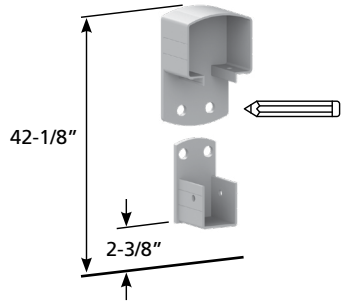

**2** For wood attachment:  
**A:** Drill 5/32" pilot holes at the marked locations.

**B:** Attach the hand and base rail brackets to the wall using four 2" lag bolts with washers.

 To prevent wood rot, coat fastener screw threads with non-corrosive exterior silicone caulking.

 For concrete attachment, refer to page 3 for anchoring fastener recommendations.

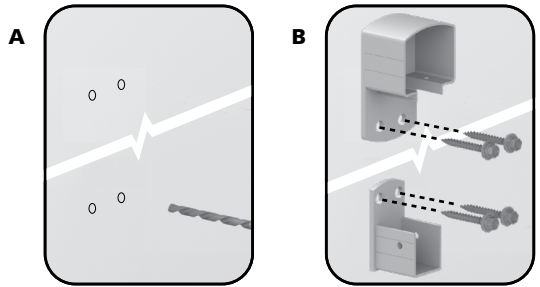

**3** Follow the Picket, 18"- 66" Glass Panel, or 6" Glass Panel installation process as shown on pages 4-9.

# HORIZONTAL ANGLE BRACKET INSTALLATION

 This symbol indicates important information.

**1** Measure and mark the hole positions of all brackets on the post.

 Maximum post spacing of 6' for Residential\* use. For commercial use, please call Peak Customer Service at 1-877-883-PEAK (7325) or email: [cservice@peakproducts.com](mailto:cservice@peakproducts.com)

\*Guards within dwelling units and exterior guards serving not more than two dwelling units.

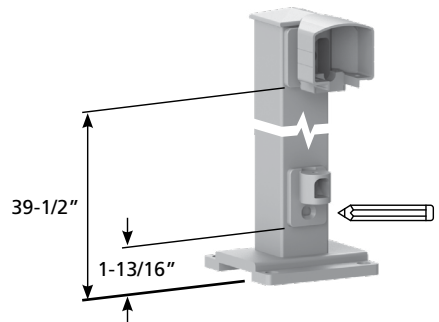

**2** **A:** Drill 7/32" pilot holes at the marked locations.

**B:** Attach the hand and base rail brackets to the post using four 1" flat head screws. Then assemble the base rail bracket using the connector bolt.

**3** Follow the Picket, 18"- 66" Glass Panel, or 6" Glass Panel installation process as shown on pages 4-9.

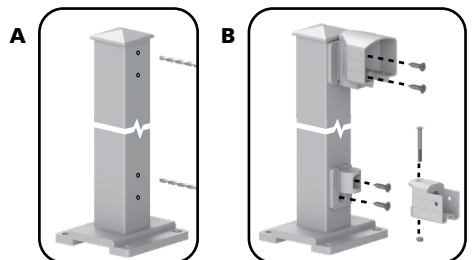

# FASCIA BRACKET INSTALLATION

 This symbol indicates important information.

 Remove covers, fasteners and base rail support from each Fascia Bracket before starting installation.

## MID/END/STAIR FASCIA BRACKET

## CORNER FASCIA BRACKET

**1** Measure and mark the position of all brackets and space equally. Put the first bracket in position, ensuring that the top of the bracket is level with the deck surface. Mark the position of the fasteners on the fascia boards.

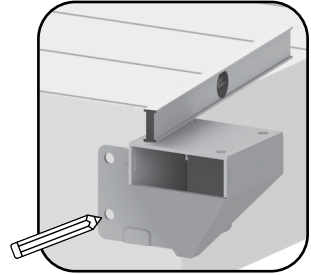
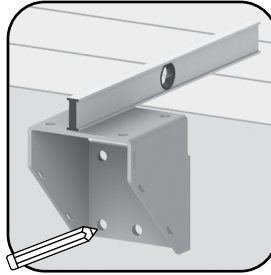

 Maximum post spacing for Residential\* use:  
decks: 6' 0"    stairs: 5' 10"

For commercial use, please call Peak Customer Service at 1-877-883-PEAK (7325) or email:  
[cservice@peakproducts.com](mailto:cservice@peakproducts.com)

\*Guards within dwelling units and exterior guards serving not more than two dwelling units.

## MID/END/STAIR FASCIA BRACKET

## CORNER FASCIA BRACKET

**2** For wood attachment:  
**A:** Remove the bracket and drill 1/4" pilot holes at the marked positions.

 To prevent splitting of the fascia board, drill 3/8" lead holes 1/2" deep at each pilot hole location.

**B:** Place the bracket back into position and attach the bracket to the fascia board using 3/8" x 4" lag bolts. Ensure that the top of the bracket is level and plumb (shim as required).

 To prevent rot, coat fastener screw threads with non-corrosive exterior silicone caulking.

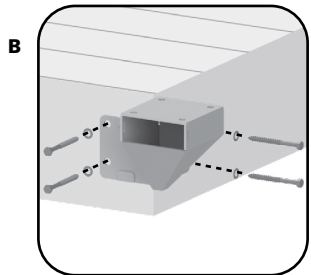
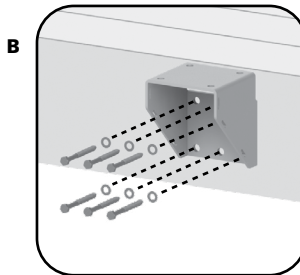
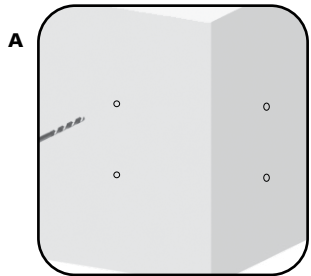
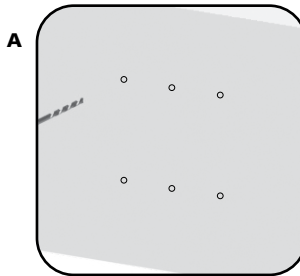

### MID/END/STAIR FASCIA BRACKET

### CORNER FASCIA BRACKET

- 3** Attach the post to the fascia bracket using four 1-1/4" bolts, washers and locking nuts. Ensure post is plumb (shim as required).

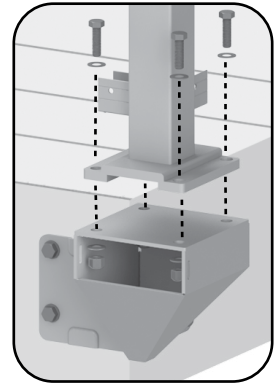
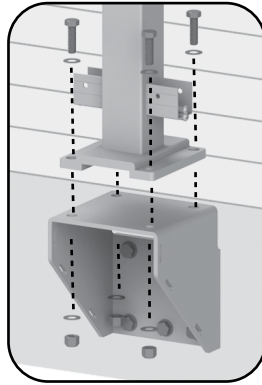

- 4** Follow the Picket, 18"-66" Glass Panel, 6" Glass Panel, or Stair Picket installation process.

**!** Use the fascia bracket base rail support when installing the base rail, and fasten to the deck using two 1-1/2" pan head screws.

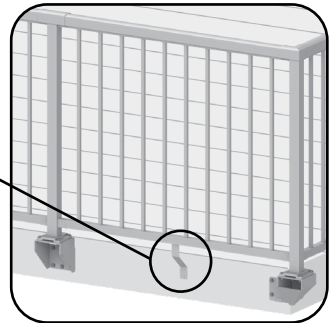
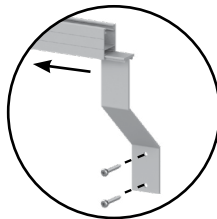

### MID/END/STAIR FASCIA BRACKET

### CORNER FASCIA BRACKET

- 5** Install covers on the brackets. Repeat all steps for the remaining brackets.

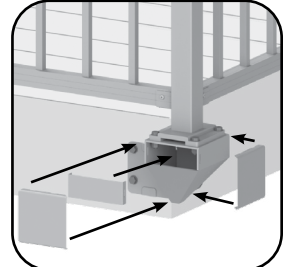
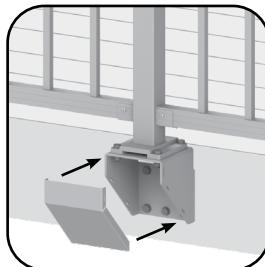

- 6** Install the post base covers. Repeat all steps for remaining sections.

# NOTES