

Installation Guide



Canadian Version



Tools & materials required for each application

All Applications

- Mitre saw with a non-ferrous metal cutting blade
- Drill
- Phillips #2 bit
- Phillips #2 screwdriver
- Slot-head screwdriver
- Level
- Socket or wrench set
- Measuring tape
- Pencil

Soft Surfaces

- Post hole digger
- Shovel
- Concrete mixing equipment
- Concrete trowel
- Dry premixed concrete (per post):

Climate with frost heave - 200 lb.*

Climate without frost heave - 100 lb.*

*Quantities are estimated. Always check your local codes for post hole size and depth.

Hard Surfaces

- Hammer drill
- Masonry bits:
7/32", 5/16"
- Hammer

LED Application

- Drill bits for metal:
1/4", 1/2", 5/8"
- Hole saw for metal: 1"
- Small round metal file
- Scissors

Fasteners included with each fence component

Rail & Picket Kit

5/8" Self-drilling screw 

Rail Kit for Glass Panel

5/8" Self-drilling screw 

3/4" Self-drilling screw 

Connector bolt 

Pool Gate

1" Self-drilling screw 

5/8" Self-tapping screw 

Hard Surface Post

Concrete anchor 

Concrete screw 

Yard Gate

1" Self-drilling screw 

Hinge bolt 

Dear Customer,

We'd like to take a moment to say "thank you and congratulations" for choosing our products. At Peak® your satisfaction is very important to us. That is why we work very hard to provide you with products of exceptional quality, value, and beauty. And that is also why we want to hear from you.

Please contact us with your comments or suggestions at:
contactus@peakproducts.com

Or if you prefer, write to us at:

"Customer Care"

The Peak Group of Companies

P.O. Box 96060

Richmond, B.C. Canada V7A 5J4

Finally, we'd like to remind you to always work safely. Then, take pride, relax with your family and experience years of enjoyment with Peak® products.

The Peak Group of Companies

WARNING No representation or warranty is given that your particular application of these products complies with relevant building codes or that the fasteners provided or used are appropriate for your application. Consult with professionals and local building officials before beginning work: (i) to ensure compliance with relevant building codes for your application and for your proposed use of fasteners; (ii) to ensure the integrity of the structural components in connection with which these products are to be used; (iii) to identify appropriate safety gear that is to be used during installation; (iv) to ensure that the work area is free from utilities, services and hazards; and (v) to clarify any instructions or warnings that may not be clear. Work in a safe manner wearing protective gear such as gloves, eyewear, headwear, footwear and clothing. When using tools comply with operation manuals and instructions. Installation materials may have sharp edges and could fragment or splinter during or as a result of handling or cutting. Do not use these products in connection with any substance that is or may be harmful or corrosive to the products. Inspect and maintain these products and the structural components that they are used in connection with on a regular basis, using professionals when appropriate.

No member of The Peak Group of Companies (as defined at www.peakproducts.com) shall be liable for any loss or damage resulting from the improper installation or use of this product. In the unlikely event that any member of The Peak Group of Companies becomes liable for any loss or damage, the aggregate liability shall be limited to the retail purchase price of the product.

Peak products and associated materials are protected by patents, designs, copyrights and/or trademarks used under license from Peak Innovations Inc.

This installation guide is updated from time to time.

Please refer to the latest version at www.peakaluminumfencing.ca

⚠ Important Information

- **Maximum post spacing:**

 - 6' 2⁵/₈" on center for a picket fence system

 - 3' 10⁵/₈" on center for a glass panel fence system

- **For pool fences:**

 - The opening between pickets, or a picket and a post must not exceed 3¹⁵/₁₆".

 - The opening between a glass panel and a post must not exceed 1¹/₂".

 - Follow local codes for minimum fence height and other specified requirements.

- **Always understand and comply with your local building codes.**

Angle Bracket Kit (for Glass Panels)

The Angle Bracket Kit (for Glass Panels) makes it easy to connect glass panels at an angle.

Angle brackets install the same way as standard brackets.

⚠ The opening between a glass panel and a post must not exceed 1¹/₂". Always understand and comply with your local building codes.

Angle Bracket Kit (for Picket Panels)

The Angle Bracket Kit (for Picket Panels) makes it easy to connect picket panels at an angle.

Angle brackets install the same way as standard brackets.

⚠ The opening between pickets, or a picket and a post must not exceed 3¹⁵/₁₆". Always understand and comply with your local building codes.

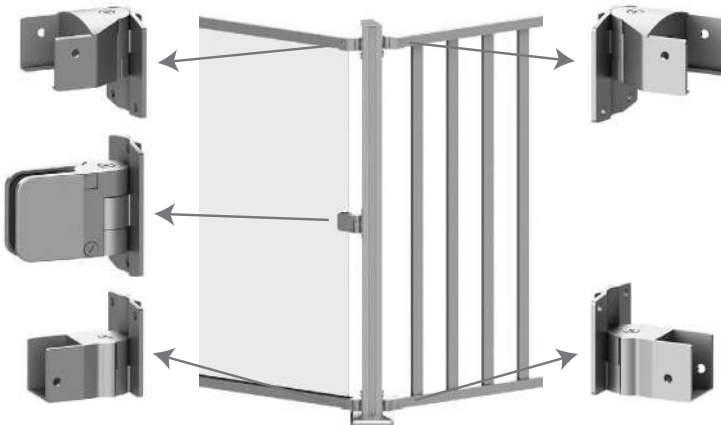

Smart lighting for your outdoors™

Follow the LED Installation section of this guide to attach the Peak™ LED Lighting system to Peak™ Aquatime™PLUS, then download the free Peak™ Lighting app.

For more information visit:

www.led.peakproducts.ca



PICKET FENCE INSTALLATION (soft surface)

 This symbol indicates important information

1

Recommended post depth underground

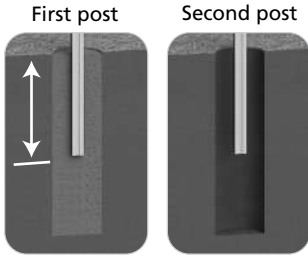

Measure and mark the position of all posts and ensure they are aligned. Dig the post holes.

 Always check your local codes for post hole size and depth. Post holes should extend below the frost line.

Fence System	Recommended post depth underground	Maximum post spacing
4' height	21"	6' 2 ⁵ / ₈ " on center
5' height	27"	

Position the first post in the post hole and brace plumb. Mix and pour concrete into the first post hole. Position and brace the second post in the post hole, but do not pour the concrete yet.

 See LED Installation, Steps 1 and 2A

2



Insert all the pickets into the rails, ensuring that the picket slots engage with the ridge on each rail.

Top Rail

3

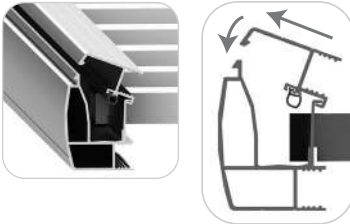

To lock the pickets into the rails, snap the side caps onto both the top rail and bottom rail.

 If the side caps do not snap in place, check that each picket is correctly seated.

Bottom Rail



4



Remove post caps and slide the bottom brackets into the slots on the first and second posts but do not fasten them yet.

5

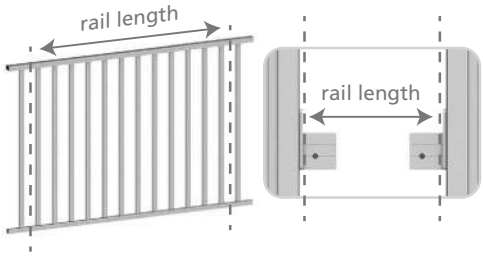

If required, cut the rails to fit between the brackets.

⚠ If you plan to cut the rails before assembling the fence panel, ensure the rails are correctly oriented before cutting.

6



Install a top bracket on each end of the top rail and fasten in place with 5/8" self-drilling screws (provided).

7

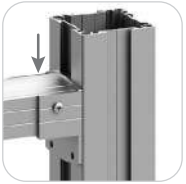

Install the assembled fence panel into the posts by sliding the top brackets into the slot on each post.

⚠ For pool fences, the opening between a picket and a post must not exceed 3¹⁵/₁₆". Always follow your local building codes.

💡 See LED Installation, Steps 3A and 3B

8



Insert bottom rail into bottom brackets and fasten together, then fasten the bottom brackets to the posts. Use 5/8" self-drilling screws (provided) for this step.

⚠ For pool fences, the opening between the bottom rail and the ground must not exceed 2". Follow local codes for minimum fence height.

9



Fasten the top brackets to both posts with the 5/8" self-drilling screws (provided), then replace post caps.

10



Level and brace the second post. Mix and pour the concrete into the second hole.

💡 See LED Installation, Steps 4 - 6

Repeat these steps for remaining sections.

PICKET FENCE INSTALLATION (hard surface)

 This symbol indicates important information

1

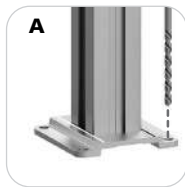

B

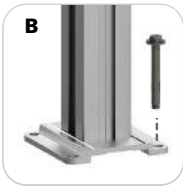

Measure and mark the position of all posts and ensure they are aligned. Put the first post in position.

 Maximum post spacing: 6' 2⁵/₈" on center.

A: Use a hammer drill with a 5/16" masonry bit to drill four holes 3" deep through each corner of the post base. Clean the holes.

B: Use a hammer to insert assembled concrete anchors until washer is touching post base. Use a 7/16" wrench to tighten the nuts. Ensure post is plumb.

 See LED Installation, Steps 1 and 2B

2



Insert all the pickets into the rails, ensuring that the picket slots engage with the ridge on each rail.

Top Rail

3

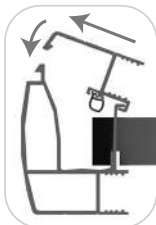

To lock the pickets into the rails, snap the side caps onto both the top rail and bottom rail.

 If the side caps do not snap in place, check that each picket is correctly seated.

Bottom Rail



4



Put the second post in position but do not fasten it yet. Remove post caps and slide the bottom brackets into the slots on the first and second posts but do not fasten them yet.

5

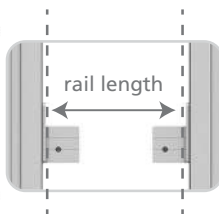
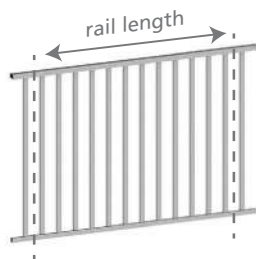

If required, cut the rails to fit between the brackets.

 If you plan to cut the rails before assembling the fence panel, ensure the rails are correctly oriented before cutting.

6



A

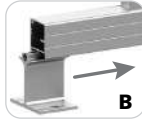

B

A: Install a top bracket on each end of the top rail and fasten in place with 5/8" self-drilling screws (provided).
B: Slide the bottom rail support into the bottom rail and move it to the center (do not fasten yet).

7

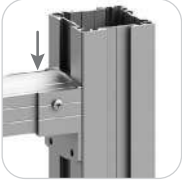

Install the assembled fence panel into the posts by sliding the top brackets into the slot on each post.

⚠ For pool fences, the opening between a picket and a post must not exceed $3\frac{15}{16}$ ". Always follow your local building codes.

💡 See LED Installation, Steps 3A and 3B

8



Use 5/8" self-drilling screws (provided) for this step. Insert bottom rail into bottom brackets and fasten together, then fasten the bottom brackets to the posts.

⚠ For pool fences, the opening between the bottom rail and the ground must not exceed 2". Follow local codes for minimum fence height.

9



Fasten the top brackets to both posts with the 5/8" self-drilling screws (provided), then replace post caps.

10



Fasten the second post to the concrete surface (see Step 1). Install bottom rail support:

A: Slide the bottom rail support to the center and mark the hole for the concrete screw (provided).

B: Use a hammer drill with a 7/32" masonry bit to drill a 2" deep hole in the concrete surface.

C: Use a 5/16" wrench to install the concrete screw.

💡 See LED Installation, Steps 4 - 6

Repeat these steps for remaining sections.

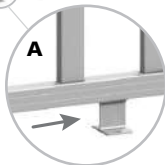

A

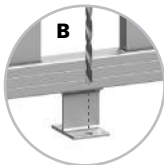

B

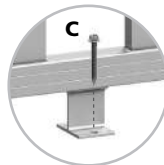

C

GLASS FENCE INSTALLATION (hard surface only)

WARNING Always use two people to handle glass panels. Always lift a glass panel by its sides. Tempered glass is extremely fragile – do not bump the edges. Always use protective gear including eyewear and gloves when handling glass panels.

 This symbol indicates important information

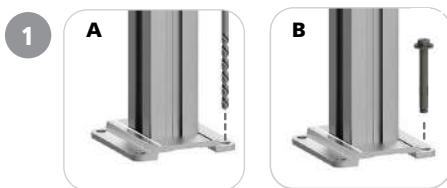
- 

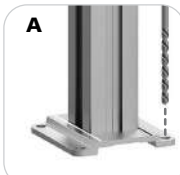
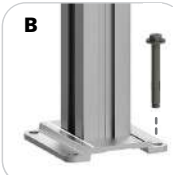

A  **B** 

Measure and mark the position of all posts and ensure they are aligned. Put the first post in position.

 Maximum post spacing: 3' 10⁵/₈" on center

A: Use a hammer drill with a 5/16" masonry bit to drill four holes 3" deep through each corner of the post base. Clean the holes.

B: Use a hammer to insert assembled concrete anchors (provided) until washer is touching post base. Use a 7/16" wrench to tighten the nuts. Ensure post is plumb.

 See LED Installation, Steps 1 and 2B
- 

2 

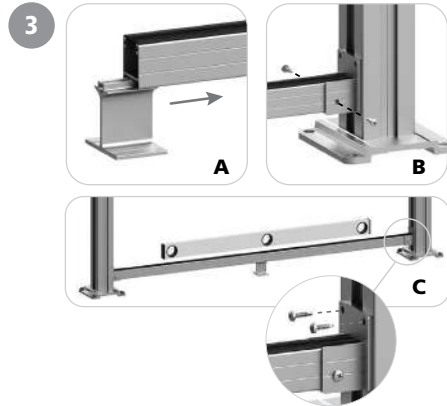
Put the second post in position but do not fasten it yet. Remove post caps and slide the bottom brackets into the slots on the first and second posts but do not fasten them yet.
- 

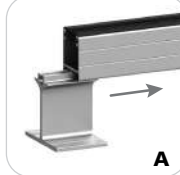
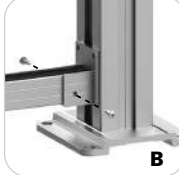
3  **A**  **B**

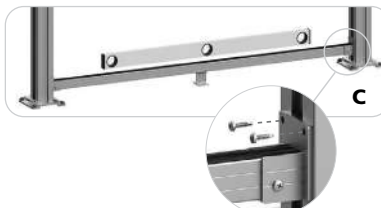
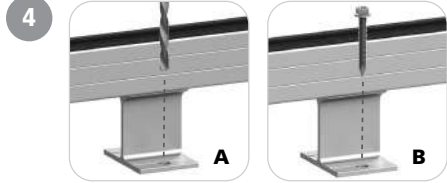

A: Slide the bottom rail support into the bottom rail and move it to the center (do not fasten yet). **B:** Insert bottom rail into bottom brackets and fasten together using the 5/8" self-drilling screws (provided). Fasten the second post to the concrete surface (see Step 1). **C:** Level the bottom rail and then fasten the bottom brackets to the posts using 5/8" self-drilling screws (provided).

 For pool fences, the opening between the bottom rail and the ground must not exceed 2". Always follow your local building codes.

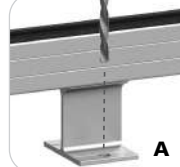
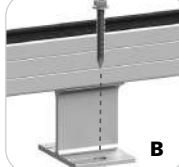
C 
- 

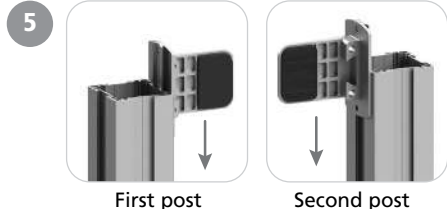
4  **A**  **B**

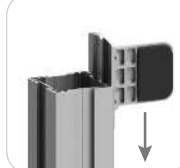
A: Center the bottom rail support and mark the hole for the concrete screw (provided). Use a hammer drill with a 7/32" masonry bit to drill a 2" deep hole in the concrete surface. **B:** Use a 5/16" wrench to install the concrete screw.
- 

5  **A**  **B**

Slide the mid brackets into the slots on both posts but do not secure them yet.

First post Second post

6

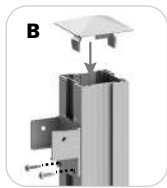
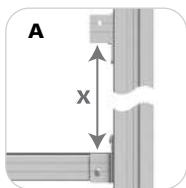

A: Measure and mark the position for the top brackets on both posts.

Fence System Distance 'x'

4' height	43½"
5' height	55½"

⚠ Follow local codes for minimum fence height.

B: Slide the top brackets into the slot on each post and fasten with the 5/8" self-drilling screws (provided), then replace the post caps.

💡 See LED Installation, Steps 3A and 3B

7



On both posts, slide the mid bracket to the center and fasten brackets into place with the 3/4" self-drilling screws (provided).

8

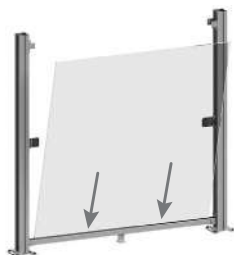

Install the glass panel into the bottom rail glass gasket.

⚠ Ensure that the glass gasket and bottom edges of the glass panel are well lubricated with liquid soap before installing the glass panel.

For pool fences, the opening between a glass panel and a post must not exceed 1/2".

9

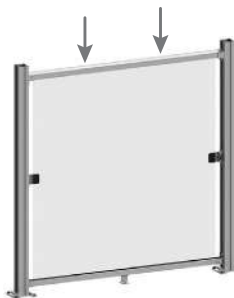

Install the top rail into the top brackets, ensuring the glass panel is fully engaged in the glass gasket.

⚠ Ensure that the glass gasket and top edges of the glass panel are well lubricated with liquid soap before installing the top rail.

Once the top rail is installed, wash away excess soap with clean water.

10

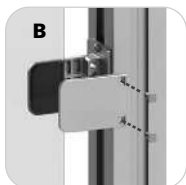
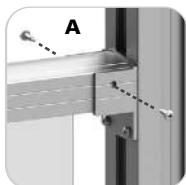

A: Fasten both top brackets to the top rail using the 5/8" self drilling screws (provided).

B: Secure the mid bracket plate using the connector bolts (provided).

⚠ Do not overtighten screws.

💡 See LED Installation, Steps 4-6

Repeat these steps for remaining sections.

LED INSTALLATION

WARNING

READ AND FOLLOW ALL WARNINGS AND SAFETY INSTRUCTIONS INCLUDED INSIDE THE LED STARTER KIT CARTON. RISK OF INJURY, ELECTRICAL SHOCK AND FIRE. CONSULT A QUALIFIED ELECTRICIAN FOR CORRECT WIRING AND SUPPLY OF ELECTRICITY.



This symbol indicates important information

1

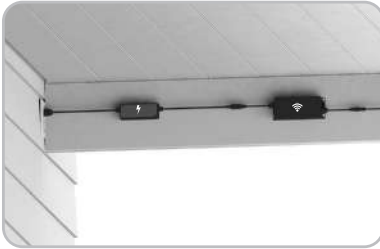

WARNING

BE SURE TO DISCONNECT THE POWER SUPPLY FROM THE POWER SOURCE BEFORE THIS STEP.

Mount the power supply and the wifi controller in a clean, dry, sheltered location near an electrical outlet with GFCI protection. The maximum recommended distance between the post at the start of the LED strip and the wifi controller is 15'.



Connecting three or more 20' extension cables before any LED strip may change the lighting intensity.

2A

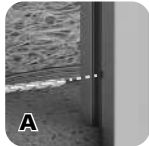

A

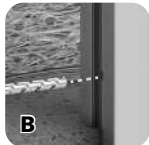

B

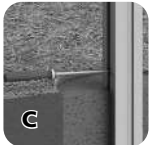

C

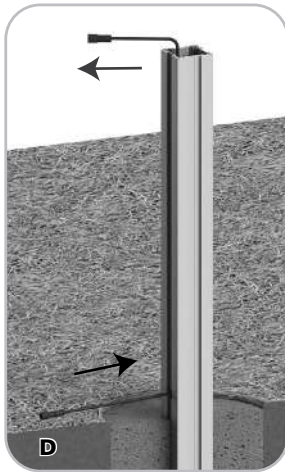

D

For a soft surface post:

Determine which post(s) you would like to pass the lighting cable(s) through.

A: Measure and mark the position of the hole for the lighting cable. Drill a 1/4" pilot hole through the side of the post

B: Finish by drilling a 5/8" hole for an extension cable, or a 1" hole for a splitter cable.

C: Use a small round metal file to remove burrs from the inside of the hole.

D: For single LED strip applications, feed the extension cable through the hole and out the top of the post. For dual LED strip applications, feed the dual end of the splitter cable through the hole and out the top of the post.

E: Connect the extension or splitter cable to the wifi controller and purchase extension cables (sold separately) if you need additional length. Determine the best way to secure and conceal the cable for your application.

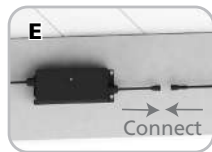

E

Connect

2B

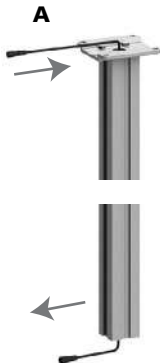

A

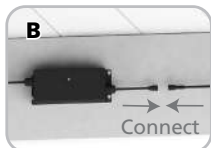

B

Connect

For a hard surface post:

Determine which post(s) you would like to pass the lighting cable(s) through.

A: For single LED strip applications, feed the extension cable through the hole in the bottom of the post and out of the top of the post. For dual LED strip applications, feed the dual end of the splitter cable through the hole in the bottom of the post and out of the top of the post.

B: Connect the extension or splitter cable to the wifi controller and purchase extension cables (sold separately) if you need additional length. Determine the best way to secure and conceal the cable for your application.

3A

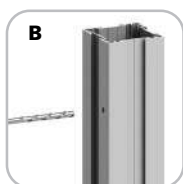

For a standard top bracket:

A: Once the location of each top bracket has been determined, mark the position of the holes for the LED strip to pass through the post.

B: Remove the assembled fence panel (for picket installation) or top bracket (for glass panel installation) and drill a 1/4" pilot hole into the post.

⚠ Ensure you drill the hole on the desired side of the post.

C: Finish by drilling a 1/2" hole.

D: Use a small round metal file to remove burrs from the inside and outside of each hole, then reinstall the assembled fence panel or top bracket. Repeat steps for each post.

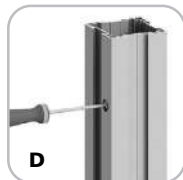

3B



For an angle top bracket:

Once the location of each angle top bracket has been determined, mark the position of the holes for the LED strip to pass through the post. Repeat steps B, C & D in 3A to drill the holes and remove burrs.

4

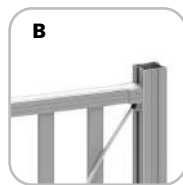
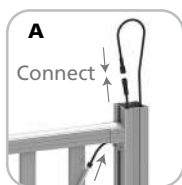

A: Feed the connector end of the LED strip through the drilled hole in the side of the post and out through the top. Connect the cables together. For dual strip applications, connect both connector ends of the LED strips to each end of the splitter cable.

B: Feed the connection(s) and remaining cable inside the post.

5

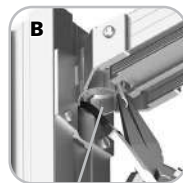
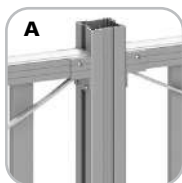

A: Before feeding the LED strip through the posts, ensure the LED strip is not twisted and that the lights are facing downward. Using two hands, **gently feed** the LED strip through the posts (**DO NOT PULL**, you will damage the strip).

⚠ To avoid damage to the strip, keep the LED strip away from sharp edges on drilled holes.

B: For angle top brackets only: use a pair of pliers to break off tabs on the cylinder, allowing the LED strip to pass through the desired side of the bracket and through the post.

Cylinder

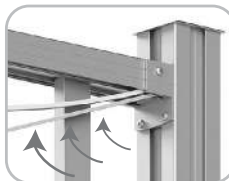

6

Strip
Cover

Starting with the first section, insert the LED strip into the LED channel in the top rail, then snap the cover in place. During this process, feed the excess LED strip into the next section. Repeat this step until the LED strip is installed in all sections. Feed any excess LED strip into the last post.

⚠ To prevent damage, do not cut the LED strip.

POOL GATE INSTALLATION

⚠ IMPORTANT: Always understand and comply with your local building codes for access gate requirements:

- Height, clearances, and openings
- Distance between the tops of horizontal members
- Location of the self-latching device above grade
- Swing direction from the pool or spa
- Self-closing
- Other specified requirements

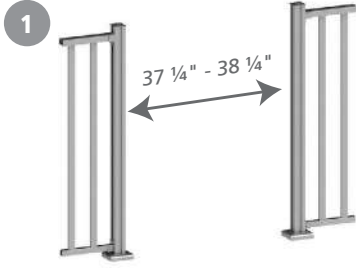

The opening between the fence posts must be $37\frac{1}{4}'' - 38\frac{1}{4}''$.

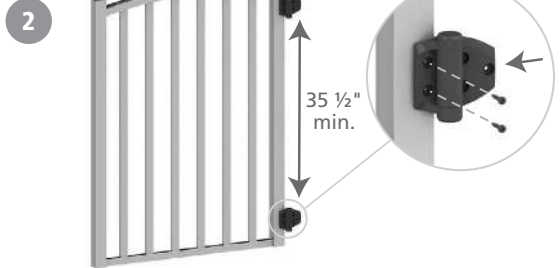

Fasten the hinges to the gate with 1" self-drilling screws (provided).

⚠ Space hinges at least $35\frac{1}{2}''$ apart

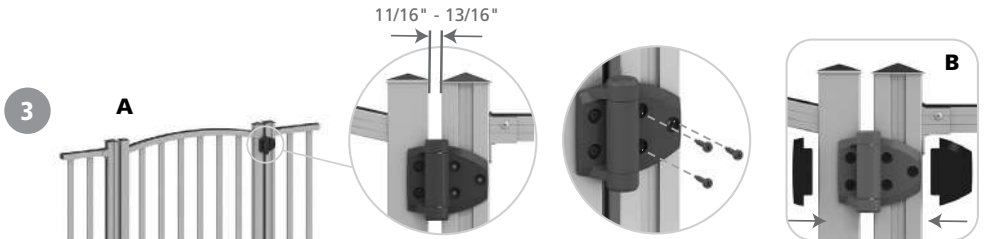

A: Align the bottom of the gate with the bottom of the fence, ensuring there is a gap of $11/16'' - 13/16''$ between the gate and the fence post. Then fasten the gate to the fence post with 1" self-drilling screws (provided).

B: Snap the covers onto both hinges.

⚠ Follow local codes for swing direction.

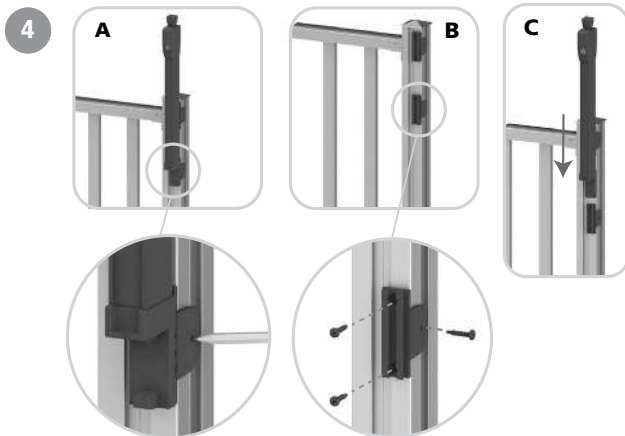

A: Position the latch at the required height on the fence post and then mark the location of both latch brackets (maximize distance between brackets).

⚠ Follow local codes for location of the self-latching device above grade.

B: Remove the latch, and fasten both latch brackets with 1" self-drilling screws (provided).

C: Slide the latch down onto the tracks of the latch brackets.

5

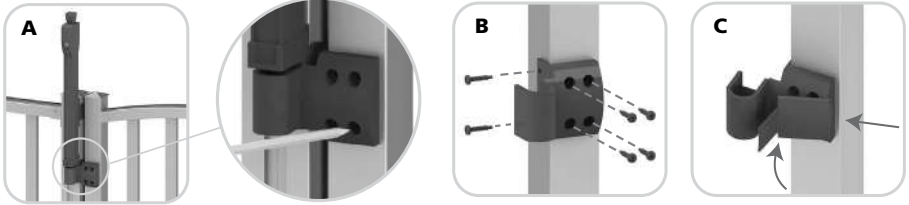

A: Position the striker with the bottom of the latch and mark the location of the mounting holes on the gate.

B: Fasten the striker to the gate with 1" self-drilling screws (provided).

C: Snap the cover onto the front of the striker.

6

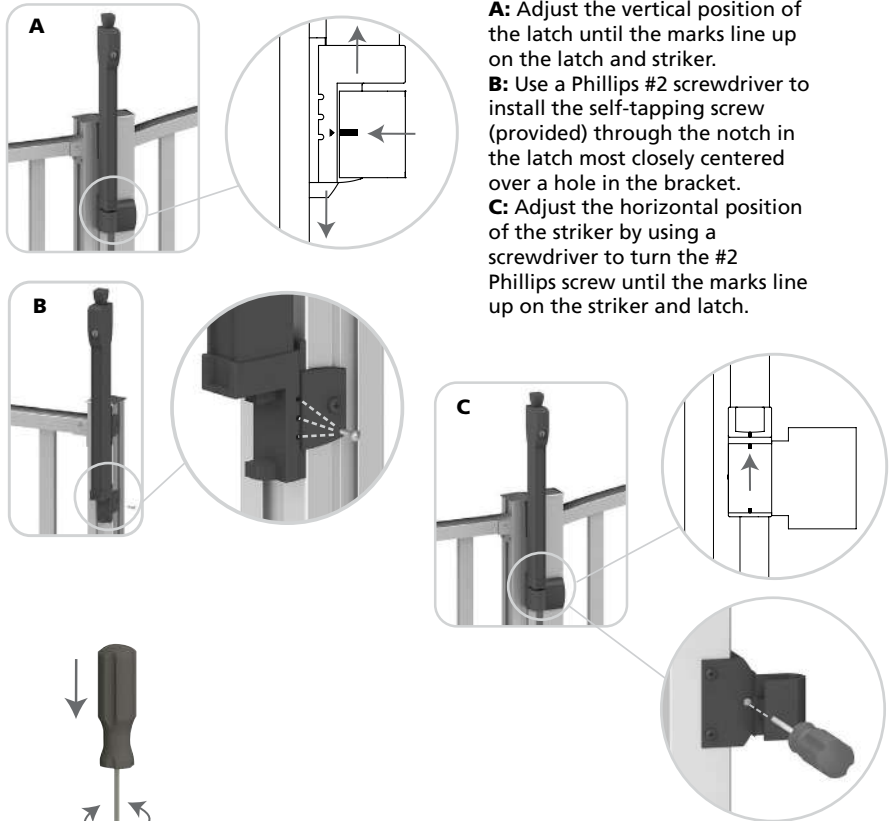

A: Adjust the vertical position of the latch until the marks line up on the latch and striker.

B: Use a Phillips #2 screwdriver to install the self-tapping screw (provided) through the notch in the latch most closely centered over a hole in the bracket.

C: Adjust the horizontal position of the striker by using a screwdriver to turn the #2 Phillips screw until the marks line up on the striker and latch.

7

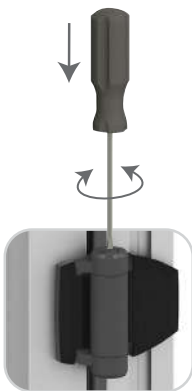

With the gate closed, adjust each hinge to the required closing tension. Use a slot-head screwdriver to depress the top adjuster on the hinge, then turn and release. Turn counter-clockwise to increase tension and clockwise to decrease tension.

⚠ The gate must be self-closing from any position.

Both hinges must have equal tension.

Adjust tension on each hinge from the top adjuster only.

YARD GATE INSTALLATION

WARNING Do not use for pool or spa applications.

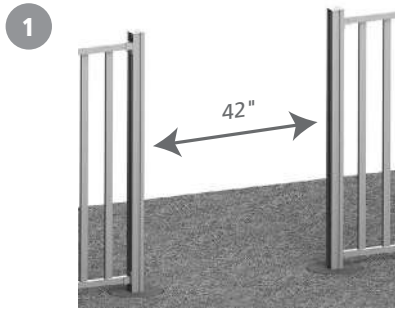

The opening between the fence posts must be 42".

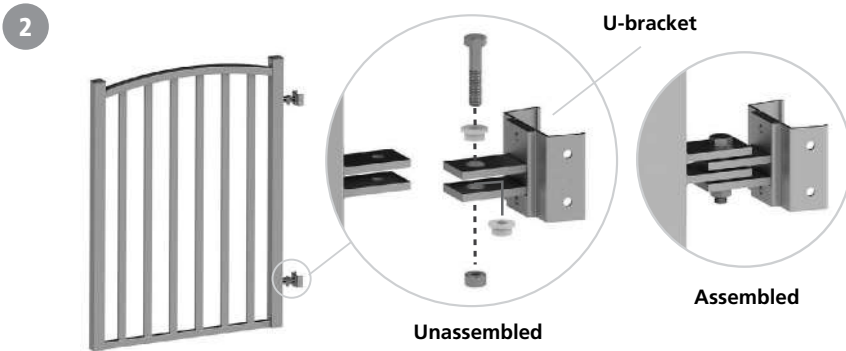

Install each hinge and U-bracket assembly on the gate and secure with bolt, bushings and nut (provided).
For wooden posts only: Do not use the U-bracket.

3A

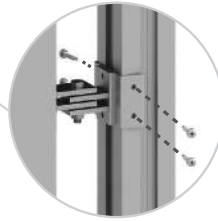

A



B

For Aquatine™ PLUS fence posts:

Use 1" self-drilling screws (provided) for these steps:

A: Align the bottom of the gate with the bottom of the fence, then fasten each U-bracket to the fence post.

B: Install the top screw on each hinge

C: Install the bottom screw on each hinge by releasing the bolt (do not completely remove)



C

3B



For wooden posts:

Secure each hinge to the fence post (fasteners not provided).

4

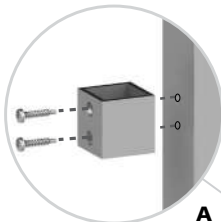

A

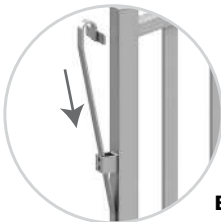
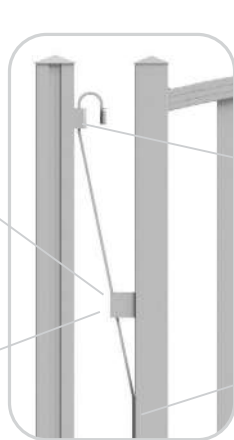

B

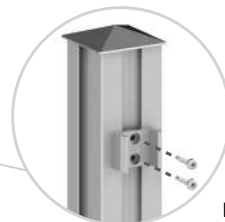

D

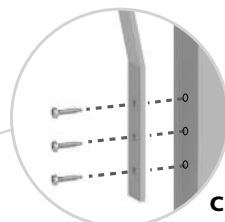

C

Use 1" self-drilling screws (provided) for these steps:

A: Secure the retainer to the gate at the marked position.

B: Insert the latch through the retainer.

C: Secure the latch to the gate at the marked position.

D: Check and mark the position for the latch plate on the fence post. Secure the latch plate to the fence post.

Notes